

# Di Lusso

where style meets technology



hunterstoves  
GROUP

## DI LUSSO BRINGS CONTEMPORARY STYLE AND INNOVATIVE FLAIR TO YOUR HOME

Our unique Dynamic Control technology has been developed to create a range of fires that can burn effectively and efficiently at both low and high temperatures - something no other fire on the market can do. This means that whatever the size of your room, there is a Di Lusso stove to suit your needs.

This innovative thinking, combined with the sleek, stylish look of the Di Lusso range, makes this one of the most sought-after fires available. Sitting flush to the wall or freestanding, and offering beautifully clear viewing glass, the Di Lusso fits effortlessly into your home, bringing any room alive with the beauty of natural flame.

The Di Lusso range has eco-conscious combustion at its core. Thanks to forward-thinking firebox technology, each stove in the collection already complies with stringent Ecodesign 2022 standards.

WARRANTY	3
ECO R4	4 - 5
ECO R5	6 - 7
ECO R6	8 - 9
ECO R6 SLIMLINE	10 - 11
ECO R4 EURO	12 - 13
ECO R5 EURO	14 - 15
ECO R4 CUBE	16 - 17
ECO R5 CUBE	18 - 19
ECO R6 CUBE	20 - 21
FEATURES   OPTIONS	22 - 23
TECHNOLOGY	24 - 26
DIMENSIONS	27 - 31



# WHERE style MEETS technology

10 YEAR WARRANTY

ALL DI LUSSO AUTHORISED DEALERS PROVIDE YOU WITH AN EXTENDED 10 YEAR WARRANTY.

For full warranty specifications and terms and a list of authorised stockists, please visit [hunterstoves.co.uk/warranty-information](http://hunterstoves.co.uk/warranty-information).



We are proud to be a Willow member of **the Woodland Trust**, the UK's leading woodland conservation charity. Our funding is helping to create, protect and restore native woodland across the UK.

Help us to restore thousands of hectares of damaged ancient woodland with landowners across the UK and in our own woods, for the benefit of wildlife.

[woodlandtrust.org.uk](http://woodlandtrust.org.uk) 01476 581111

DI LUSSO

# ECO R4

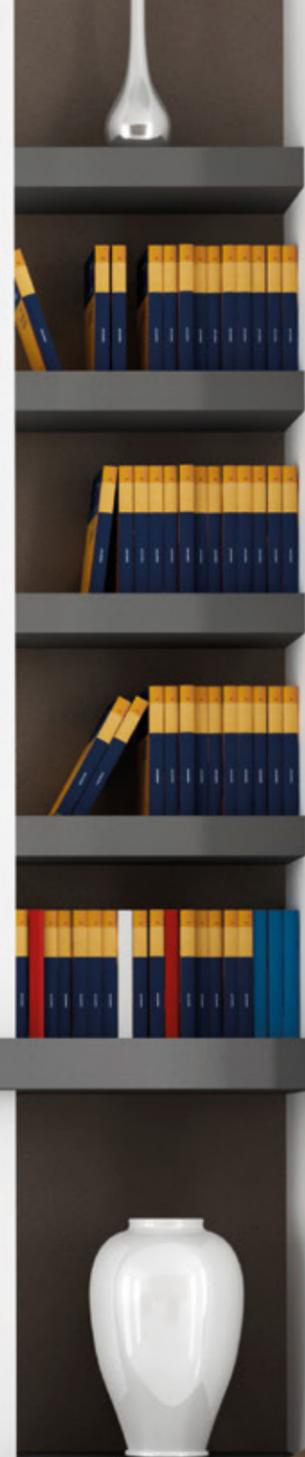

THE DI LUSSO RANGE BRINGS FLEXIBILITY TO YOUR FINGERTIPS. EACH STOVE OFFERS YOU COMPLETE CONTROL OVER YOUR ROOM TEMPERATURE, SOMETHING MANY OTHER FIRES ARE UNABLE TO PROVIDE.

The Di Lusso Eco R4 may be the smallest, most compact stove in the range, but it still packs a powerful punch. The R4 is ideal for smaller rooms, able to fit comfortably into a standard 16" fireplace.

- ECODESIGN READY
- DEFRA APPROVED
- CONVECTION STOVE
- NO AIR BRICK REQUIRED
- DYNAMIC AIR CONTROL CASSETTE
- ADVANCED FIREBOX TECHNOLOGY
- HOT AIRWASH SYSTEM
- DIRECT AIR \*

\* With optional kit

ENERGY EFFICIENCY CLASS **A**

HEAT OUTPUT **2kW TO 6kW**

NOMINAL **4.9kW**



ECO R4 with 4-Sided Black Frame

ECO R4 with 3-Sided Pewter Frame

DI LUSSO

# ECO R5



THE DI LUSSO ECO R5 IS THE IDEAL ADDITION TO ANY ROOM, LARGE OR SMALL. FITTING FLUSH TO THE WALL, THIS INSET STOVE OFFERS A STYLISH FOCAL POINT WHILST UTILISING SPACE EFFICIENTLY.

With innovative firebox technology and an advanced Dynamic Control system, the Eco R5 is one of the easiest stoves to control on the market.

- ECODESIGN READY
- DEFRA APPROVED
- CONVECTION STOVE
- DYNAMIC AIR CONTROL CASSETTE
- E.A.D. FLAME TECHNOLOGY
- HOT AIRWASH SYSTEM
- DIRECT AIR\*

\* With optional kit

ENERGY EFFICIENCY CLASS **A**

HEAT OUTPUT **3kW TO 13kW**

NOMINAL **6.3kW**



Eco R5 with 4-Sided Black Frame

Eco R5 with 3-Sided Black Frame



DI LUSO

# ECO R6



THE ECO R6 REALLY IS THE KING OF STOVES, THANKS TO ITS DYNAMIC AIR CONTROL SYSTEM, EFFORTLESS CONTEMPORARY STYLING AND INNOVATIVE, NEXT-GENERATION TECHNOLOGY.

Its sleek lines and smooth finish will set off any room, creating a stunning focal point that will wow friends and family alike.

- ECODESIGN READY
- DEFRA APPROVED
- CONVECTION STOVE
- TRAPEZOID DESIGN
- DYNAMIC AIR CONTROL CASSETTE
- E.A.D. FLAME TECHNOLOGY
- HOT AIRWASH SYSTEM
- DIRECT AIR \*

\* with optional kit

ENERGY EFFICIENCY CLASS **A+**

HEAT OUTPUT **4kW TO 13kW**

NOMINAL **6.2kW**



Eco R6 with 4-Sided Black Frame

Eco R6 with 3-Sided Pewter Frame



DI LUSO

ECO

R

6

SLIMLINE



THE DI LUSO ECO R6 SLIMLINE IS SIMPLY STUNNING. IT GRACEFULLY COMBINES SCIENCE AND STYLE TO MAKE A STRIKING STATEMENT IN YOUR HOME.

A slimmer version of the original R6, this Di Lusso model boasts advanced firebox technology and a truly exquisite finish, all whilst utilising space efficiently.

ECODESIGN READY

DEFRA APPROVED

CONVECTION STOVE

TRAPEZOID DESIGN

DYNAMIC AIR CONTROL CASSETTE

E.A.D. FLAME TECHNOLOGY

HOT AIRWASH SYSTEM

DIRECT AIR\*

\* with optional kit

ENERGY EFFICIENCY CLASS **A**

HEAT OUTPUT **4kW TO 9kW**

NOMINAL **6.2kW**



Eco R6 Slimline with 4-Sided Black Frame

Eco R6 Slimline with 3-Sided Pewter Frame



DI LUSO

# ECO R4 EURO



A SLEEK FUSION OF ELEGANCE AND INNOVATION, THE VERSATILE ECO R4 EURO REALLY IS THE BEST OF BOTH WORLDS.

With optional sides available, you can tailor the finish of the Eco R4 Euro stove so that it effortlessly complements any room.

- ECODESIGN READY
- DEFRA APPROVED
- CONVECTION STOVE
- NO AIR BRICK REQUIRED
- DYNAMIC AIR CONTROL CASSETTE
- ADVANCED FIREBOX TECHNOLOGY
- HOT AIRWASH SYSTEM
- DIRECT AIR \*
- CUSTOMISABLE FINISH
- REAR TO COMBUSTIBLE CLEARANCE DISTANCE 50mm
- SIDE TO COMBUSTIBLE CLEARANCE DISTANCE 100mm
- CAN BE FITTED ON A 12mm HEARTH

\* with optional kit

ENERGY EFFICIENCY CLASS **A**

HEAT OUTPUT **2kW TO 6kW**

NOMINAL **4.9kW**

Eco R4 Euro with Curved Stainless Steel Sides



DI LUSO

ECO  
R5  
EURO



WITH A LARGE VIEWING WINDOW AND STYLISH LOOKS, THE ECO R5 EURO ADDS A TOUCH OF THEATRE, CREATING AN ELEGANT CENTREPIECE IN ANY ROOM.

With a combination of minimal clearance distances from any wall, an impressive heat range and customisable finishes, the Eco R5 Euro offers both style and substance.

- ECODESIGN READY
- DEFRA APPROVED
- CONVECTION STOVE
- DYNAMIC AIR CONTROL CASSETTE
- E.A.D. FLAME TECHNOLOGY
- HOT AIRWASH SYSTEM
- DIRECT AIR\*
- CUSTOMISABLE FINISH
- REAR TO COMBUSTIBLE CLEARANCE DISTANCE 10mm
- SIDE TO COMBUSTIBLE CLEARANCE DISTANCE 50mm
- CAN BE FITTED ON A 12mm HEARTH

\* with optional kit

ENERGY EFFICIENCY CLASS **A**

HEAT OUTPUT **3kW TO 13kW**

NOMINAL **6.3kW**

Eco R5 Euro with Curved Black Sides



DI LUSSO

# ECO R4 CUBE



Eco R4 Cube Quattro with bench

WITH TWO EYE-CATCHING ECO R4 CUBE MODELS AVAILABLE, THERE IS A DESIGN TO SUIT EVERY HOME.

Boasting low CO emissions of only 0.09%, the Eco R4 Cube will make a huge statement in your home, without impacting on the environment.

- ECODESIGN READY
- DEFRA APPROVED
- CONVECTION STOVE
- NO AIR BRICK REQUIRED
- DYNAMIC AIR CONTROL CASSETTE
- ADVANCED FIREBOX TECHNOLOGY
- HOT AIRWASH SYSTEM
- DIRECT AIR \*
- REAR TO COMBUSTIBLE CLEARANCE DISTANCE 50MM

\* with optional kit

ENERGY EFFICIENCY CLASS **A**

HEAT OUTPUT **2kW TO 6kW**

NOMINAL **4.9kW**



Eco R4 Cube Arco



DI LUSO

ECO

R

S

CUBE



SITTING IN A FIREPLACE,  
FREESTANDING, OR ON A BENCH,  
THE ECO R5 CUBE MODELS FIT  
EFFORTLESSLY INTO ANY ROOM.

As with all Di Lusso fires, the Eco R5 Cube  
is a convector, forming hot streams  
of air which flow into your home and  
ensure even and comfortable heating.

- ECODESIGN READY
- DEFRA APPROVED
- CONVECTION STOVE
- DYNAMIC AIR CONTROL CASSETTE
- E.A.D. FLAME TECHNOLOGY
- HOT AIRWASH SYSTEM
- DIRECT AIR\*
- REAR TO COMBUSTIBLE  
CLEARANCE DISTANCE 50MM

\* with optional kit

ENERGY EFFICIENCY CLASS **A**

HEAT OUTPUT **3kW TO 13kW**

NOMINAL **6.3kW**



Eco R5 Cube Quattro

Eco R5 Cube Arco



DI LUSSO

# ECO R6 CUBE



BY PAIRING TECHNOLOGY WITH STYLE, THE ECO R6 CUBE CREATES A STRIKING FEATURE WHILST BEING HIGHLY CONTROLLABLE.

The largest stove of the Di Lusso range, the Eco R6 Cube boasts an impressive output of between 4kW and 13kW, giving you the option of a hot roaring fire or a couple of flickering flames.

- ECODESIGN READY
- DEFRA APPROVED
- CONVECTION STOVE
- TRAPEZOID DESIGN
- DYNAMIC AIR CONTROL CASSETTE
- E.A.D. FLAME TECHNOLOGY
- HOT AIRWASH SYSTEM
- DIRECT AIR \*
- REAR TO COMBUSTIBLE CLEARANCE DISTANCE 50MM

\* with optional kit

ENERGY EFFICIENCY CLASS **A**

HEAT OUTPUT **4kW TO 13kW**

NOMINAL **6.2kW**



Eco R6 Cube Quattro

Eco R6 Cube Arco



# FEATURES

	ECO R4	ECO R5	ECO R6	ECO R6 SLIMLINE	ECO R4 EURO	ECO R5 EURO	ECO R4 CUBE	ECO R5 CUBE	ECO R6 CUBE
HEAT OUTPUT RANGE (kW)	2 - 6	3 - 13	4 - 13	4 - 9	2 - 6	3 - 13	2 - 6	3 - 13	4 - 13
NOMINAL HEAT OUTPUT (kW)	4.9	6.3	6.2	6.2	4.9	6.3	4.9	6.2	6.2
EFFICIENCY ON WOOD (%)	79	81	77	77	79	81	79	81	77
CO EMISSIONS (at 13% O <sub>2</sub> ; %)	0.09	0.12	0.09	0.09	0.09	0.12	0.09	0.12	0.09
AIR BRICK REQUIRED	N	Y	Y	Y	N	Y	N	Y	Y
MINIMUM HEARTH THICKNESS (mm)	NA	NA	NA	NA	FREESTANDING: 12 RECESSED: 125	FREESTANDING: 12 RECESSED: 125	125	125	125
DEFRA APPROVED	Y	Y	Y	Y	Y	Y	Y	Y	Y
ECODESIGN READY	Y	Y	Y	Y	Y	Y	Y	Y	Y
DIRECT AIR KIT AVAILABLE	Y	Y	Y	Y	Y	Y	Y	Y	Y
MULTI FUEL	O	O	O	O	O	O	O	O	O
WOOD BURNING	S	S	S	S	S	S	S	S	S
LOG LENGTH (mm)	250	350	330	330	250	350	250	350	330
WEIGHT (kg)	70	121	116	107	106	184	106	150	140

N No    Y Yes    O Option    S Standard

CONTACT YOUR DEALER FOR INSTALLATION ADVICE.

	ECO R4	ECO R5	ECO R6	ECO R6 SLIMLINE
3-SIDED BLACK FRAME	✓	✓	✓	✓
3-SIDED PEWTER FRAME	✓	✓	✓	✓
4-SIDED BLACK FRAME	✓	✓	✓	✓
4-SIDED PEWTER FRAME	✓	✓	✓	✓
	ECO R4 EURO		ECO R5 EURO	
FLAT SIDED BLACK	✓		✓	
CURVED SIDED BLACK	✓		✓	
CURVED SIDED BRUSHED STEEL	✓		✓	
	ECO R4 CUBE	ECO R5 CUBE	ECO R6 CUBE	
ARCO	✓	✓	✓	
QUATTRO	✓	✓	✓	

✓ Option available

THE DI LUSO CUBE MODELS HAVE THE OPTION OF BEING FITTED ON A BENCH.

Available in two sizes, these benches are both stylish and practical. Not only does their sleek design complement the elegance of the Di Lusso range, they also provide a handy place to store logs.

Choose between two lengths: 800mm and 1,195mm. Both bench models have a height of 345mm and depth of 415mm.



INSET  
MODEL  
OPTIONS

EURO  
MODEL  
OPTIONS

CUBE  
MODEL  
OPTIONS

BENCHES

**AT DI LUSSO, OUR ENGINEERS HAVE BEEN DEVELOPING NEW AND FORWARD-THINKING SYSTEMS TO IMPROVE COMBUSTION.**

Our Exact Air Delivery (EAD) Flame Technology is a cutting-edge system that ensures a more complete combustion of the fuel used. It has been developed to maximize heat extraction and to further lower emissions even at lower burn temperatures.

**HOW IT ALL WORKS**

Targeted distribution and circulation of air inside a firebox allows for an optimal mixture of oxygen and combustions gases, which in turn provides the best conditions for a more complete combustion.

Conventional wood burning stoves often provide

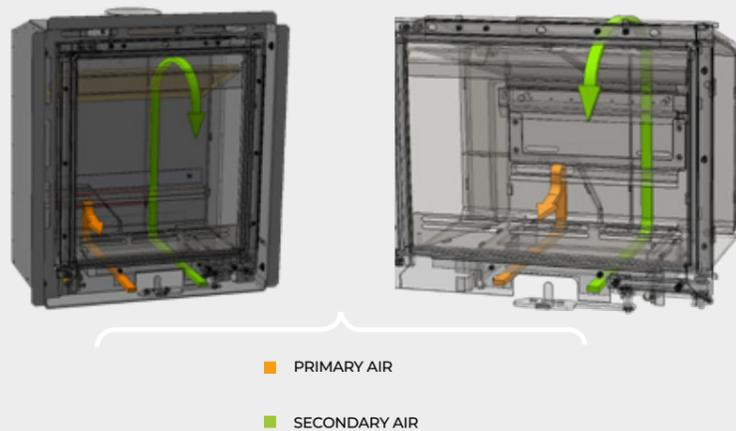

insufficient or excess aeration of the firebox. If there is a lack of air to support complete combustion, this leads to poor fuel and air mixture, which in turn reduces efficiency and increases emissions. If there is excess air, the firebox will be cooled, combustion accelerated, and efficiency lost.

Di Lusso EAD Flame Technology utilizes targeted primary and secondary air streams. These streams are directed and optimised to enter the combustion chamber at the precise locations and in the correct ratios. They ensure that the air traveling through the firebox creates the required turbulence to correctly mix combustion gases and oxygen, thus enhancing the stove's efficiency and minimising emissions.

**HOT AIRWASH SYSTEM**

Heated air is drawn across the glass window of the stove, creating a screen between the flames and the window. This reduces the build-up of carbon deposits on the glass, guaranteeing an excellent view of your fire as it burns.

**INNOVATIVE DUAL BAFFLE SYSTEM**

The Dual Baffle System increases the residence time of the flue gases in the stove by extending their

circulation inside the firebox. This keeps the gases present for an optimal period, providing sufficient time for these substances to mix with oxygen and to be greatly eliminated in the combustion process. This enhances the heat produced by the firebox.

**IMPROVED HEAT RETENTION**

Di Lusso Eco fireboxes have been designed to focus radiant heat back into the fire bed. This allows the fire bed to maintain an elevated temperature, which in turn contributes to a greater fuel efficiency.



**DI LUSSO DYNAMIC CONTROL GIVES THE USER COMPLETE POWER OVER THE TEMPERATURE OUTPUT - UNLIKE MOST STOVES.**

This intuitive control system allows the user to increase or decrease the stove's burn with just the turn of a dial, which is cleverly hidden behind the integrated door handle.



■ ONE TOUCH ACCESS - magnetic integrated door handle



■ DYNAMIC CONTROL SYSTEM  
■ PRIMARY AIR  
■ SECONDARY AIR



LOW



HIGH



**ALL DI LUSSO PRODUCTS HAVE BEEN CREATED TO MEET DEFRA'S CLEAN AIR APPROVALS AND TO COMPLY WITH SMOKE CONTROL AREA REGULATIONS\*.**

A small adjustment to the combustion air valve on the dynamic control cassette ensures a constant flow of air through the combustion valve. This prevents smouldering when the fire is performing at lower temperatures.

\* Speak to your dealer about DEFRA Smoke Control Regulations in your area.



DIRECT AIR  
KIT

ALL DI LUSSO STOVES CAN BE PURCHASED WITH A DIRECT AIR KIT IF DESIRED OR REQUIRED.

A DIRECT AIR KIT ALLOWS THE DI LUSSO TO PERFORM AT ITS BEST, INDEPENDENTLY FROM THE INTERNAL AIR SUPPLY, BY ENSURING THAT AIR FOR AIDING COMBUSTION IS BROUGHT IN EXTERNALLY.

OPTIONAL  
EXTRA

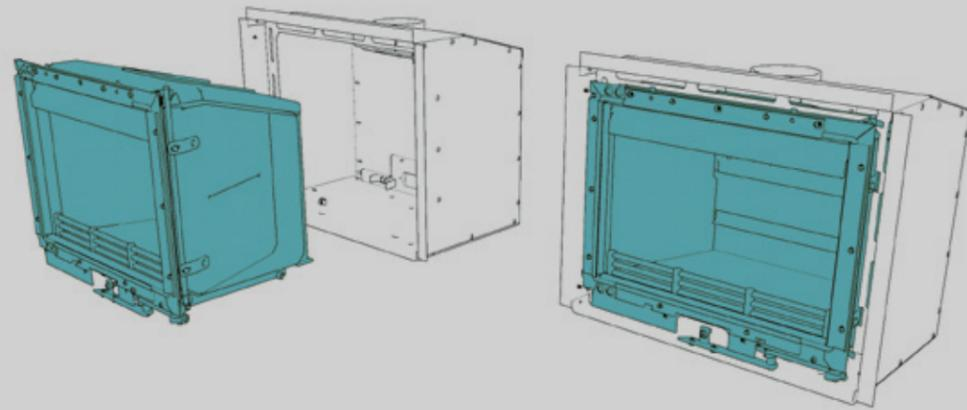

For easier installation of the Eco R5 and Eco R6, we have developed a convection chamber that can be fitted as a separate unit from the firebox.

Additionally, the flue collar can be fitted at either a 30° angle or vertical, depending on the specific needs of the installation.

EASY INSTALLATION  
R5 & R6

ALL DI LUSSO MODELS ARE TESTED TO NORWEGIAN STANDARDS.

The Di Lusso undergoes stringent testing to ensure we are providing a product which pushes boundaries.

The DS EN 13229 is the CE requirement test for output and efficiency. This ensures that the Di Lusso range is performing at optimum levels.

For particulate emissions, we test to the much tougher Norwegian standard, the NS 3059. This is a harder standard to meet than the British smoke control standard. We test at this level because the Di Lusso stoves must meet particulate emission standards even when burning at a greatly reduced output. It is the Di Lusso's ability to meet this standard, through its forward-thinking technology and its innovative controllability, that sets it apart from all other stoves on the market.

TESTING

DI LUSSO

ECO  
R4  
DIMENSIONS

4-SIDED FRAME  
FRONT VIEW

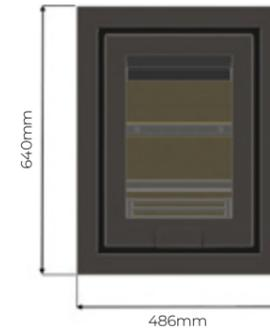

3-SIDED FRAME  
FRONT VIEW

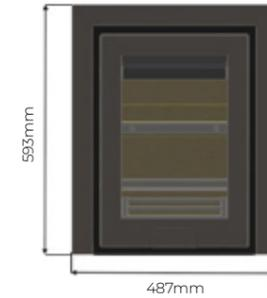

SIDE VIEW

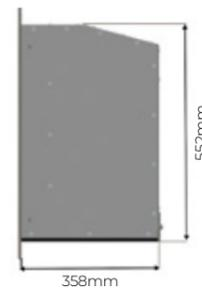

TOP VIEW

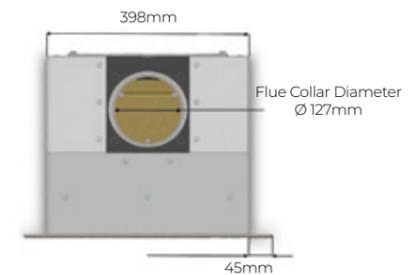

SIDE VIEW INTERNAL  
ANGLED OUTLET

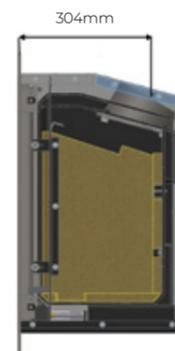

SIDE VIEW INTERNAL  
STRAIGHT OUTLET



For full information on installation criteria, please refer to the instruction manual. These can be found on [hunterstoves.co.uk](http://hunterstoves.co.uk) or by contacting your dealer.

4-SIDED FRAME  
FRONT VIEW

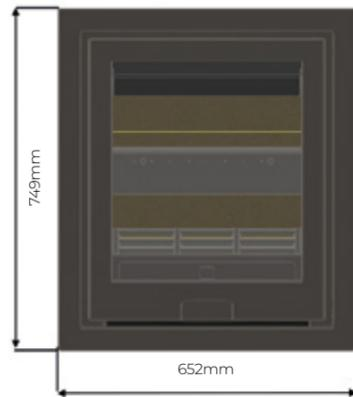

3-SIDED FRAME  
FRONT VIEW

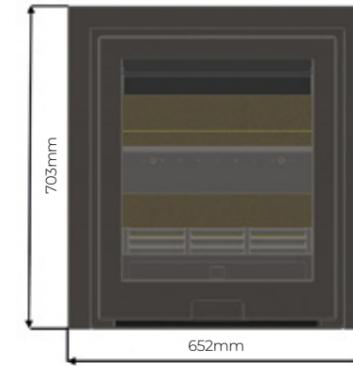

R6 & R6 SLIMLINE  
4-SIDED FRAME  
FRONT VIEW

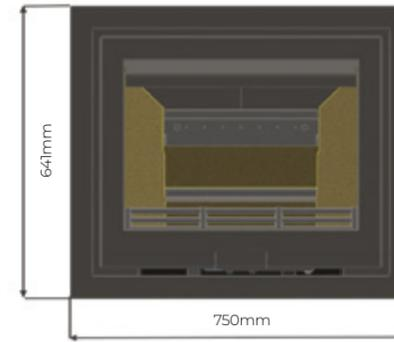

R6 & R6 SLIMLINE  
3-SIDED FRAME  
FRONT VIEW

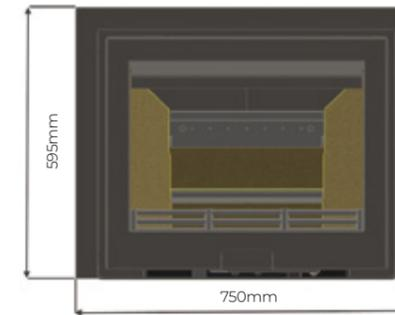

TOP VIEW

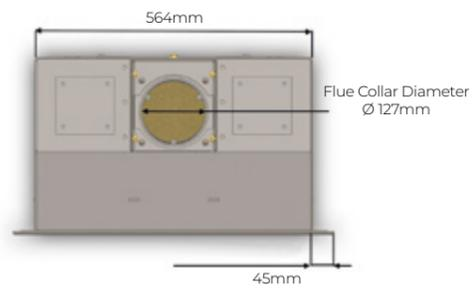

SIDE VIEW

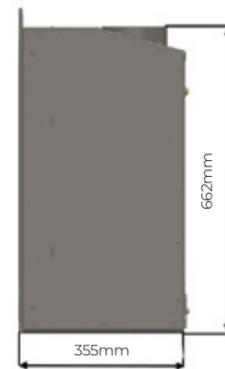

R6  
SIDE VIEW



R6 SLIMLINE  
SIDE VIEW



TOP VIEW

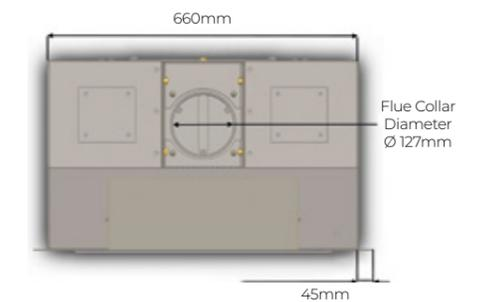

SIDE VIEW INTERNAL  
ANGLED OUTLET



SIDE VIEW INTERNAL  
STRAIGHT OUTLET



R6  
SIDE VIEW INTERNAL  
ANGLED OUTLET

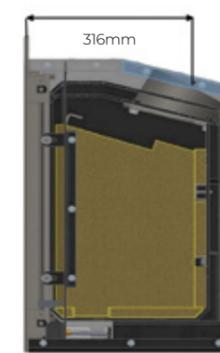

R6  
SIDE VIEW INTERNAL  
STRAIGHT OUTLET

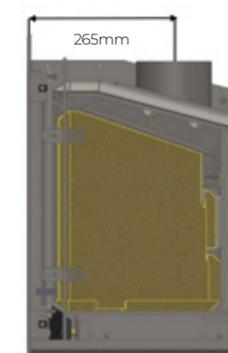

R6 SLIMLINE  
SIDE VIEW INTERNAL  
ANGLED OUTLET

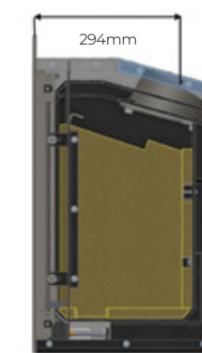

R6 SLIMLINE  
SIDE VIEW INTERNAL  
STRAIGHT OUTLET



For full information on installation criteria, please refer to the instruction manual. These can be found on [hunterstoves.co.uk](http://hunterstoves.co.uk) or by contacting your dealer.

DI LUSSO  
ECO  
R4  
EURO  
DIMENSIONS

FRONT VIEW



SIDE VIEW



R4 CUBE QUATTRO / ARCO FRONT VIEW

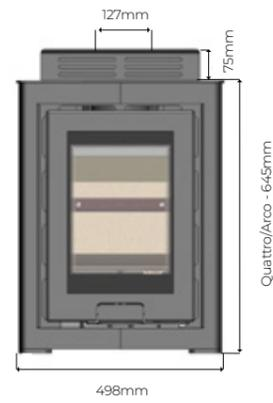

R4 CUBE SIDE VIEW



TOP VIEW FLAT SIDES

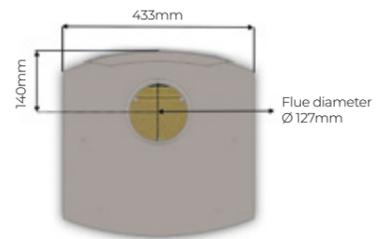

TOP VIEW CURVED SIDES

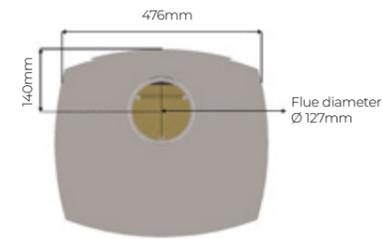

R5 CUBE QUATTRO / ARCO FRONT VIEW

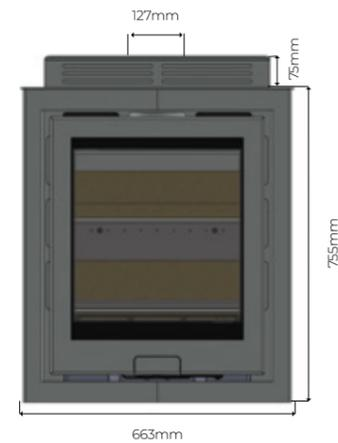

R5 CUBE SIDE VIEW



FRONT VIEW



SIDE VIEW



R6 CUBE QUATTRO / ARCO FRONT VIEW

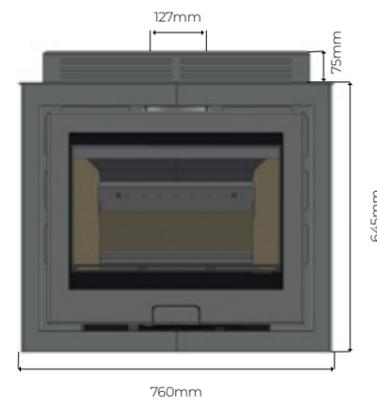

R6 CUBE SIDE VIEW

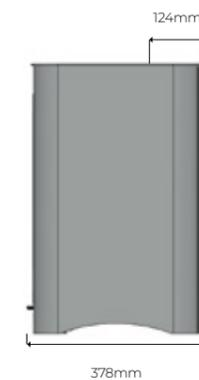

TOP VIEW FLAT SIDES

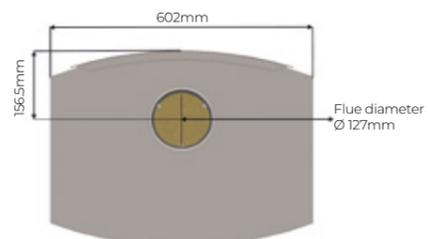

TOP VIEW CURVED SIDES

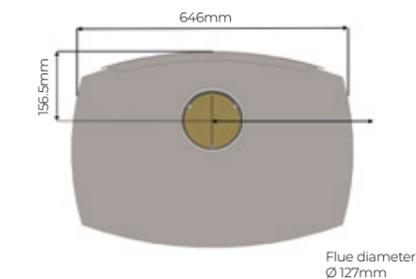

DI LUSSO  
ECO  
R4  
CUBE  
DIMENSIONS

DI LUSSO  
ECO  
R5  
CUBE  
DIMENSIONS

DI LUSSO  
ECO  
R5  
EURO  
DIMENSIONS

DI LUSSO  
ECO  
R6  
CUBE  
DIMENSIONS

For full information on installation criteria, please refer to the instruction manual. These can be found on [hunterstoves.co.uk](http://hunterstoves.co.uk) or by contacting your dealer.



# Di Lusso

8 EMPEROR WAY EXETER DEVON EX1 3QS

INFO@HUNTERSTOVES.CO.UK WWW.HUNTERSTOVES.CO.UK



HSC-DL-UK-0119